

HIGH POWER

HAKKOFX-838 ESD SAFE
SOLDERING STATION

150W

Heavy-duty soldering iron

Good news for users struggling with soldering power-supply boards, multilayer boards, heat sinks and shield cases, which require high heat capacity! Outstanding performance solves these challenging problems.



 **HAKKO**

HIGH POWER



High power 150W

Great thermal recovery

150W hand piece provides great thermal recovery, which allows soldering at lower set temperatures to minimize concern about the influence of heat on components and tip life.

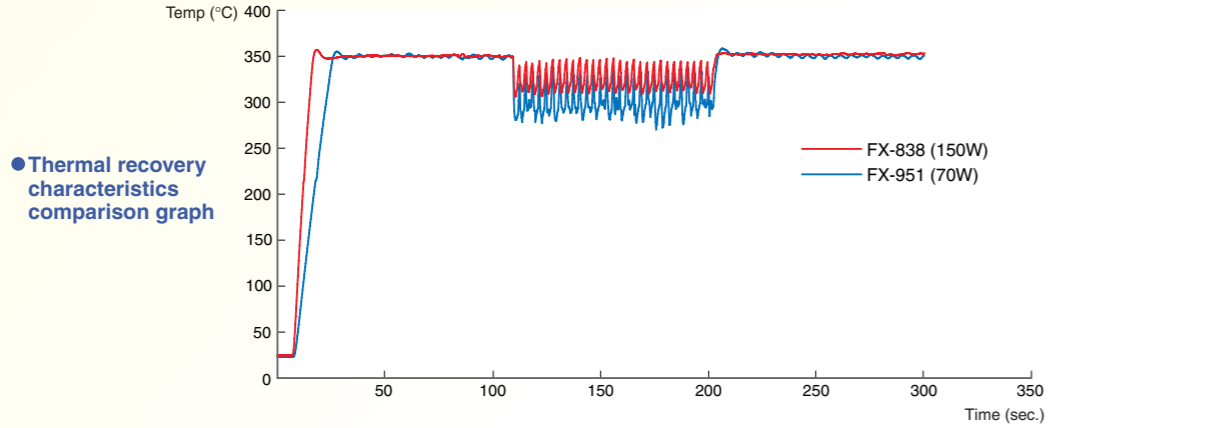

● Thermal recovery characteristics comparison graph

[Test criteria] ● Tip shape: 2.4D Board: Paper phenol copper Solder: ϕ 1.6 x 5mm Cycle: Every 3 sec. ● Lead-free solder is used.

Improvement of work efficiency

- It is suitable for soldering power-supply boards, multilayer boards, heat sinks and shield cases, which require high heat capacity. It is also appropriate for soldering multilayer boards on which fine and micro components have been mounted.
- It has beneficial effects on lead-free soldering, for which the melting point is high.

Easy to replace tips

Tips can be quickly and easily replaced because they are of the cartridge type.

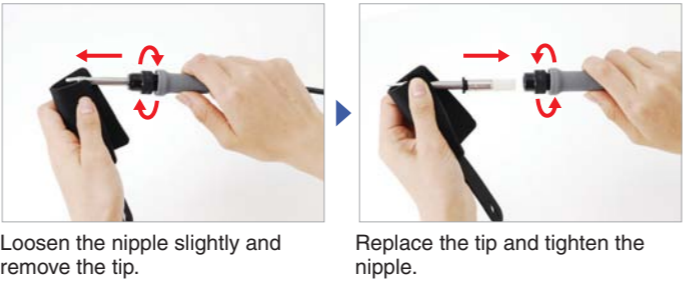

Available 20 different shapes as the replacement tip

To match various application, from large to fine components, we reviewed the shape of each tip type in detail and pursued heat efficiency and ease of use. (For tip shapes, please refer to the back cover.)

Equipped with high-power mode

If the work efficiency in the standard mode is not enough when soldering heat sinks, shield cases and chassis, which require high heat capacity in particular, changing to the high-power mode provides more powerful soldering.

* When this mode starts, fluctuation in temperature may occur.

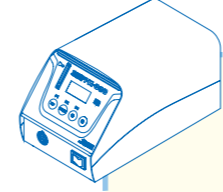

Temperature preset mode

The temperature preset mode allows you to input three frequently-used temperatures in advance and recall them with one push of a button.

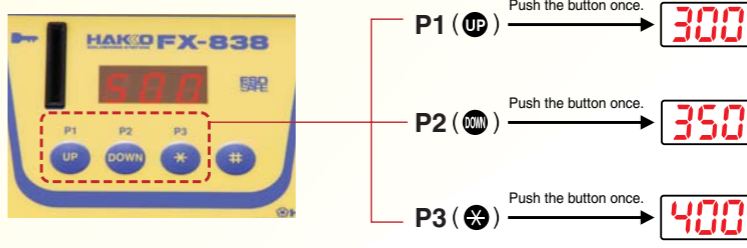

* Factory default is nomal. Change the parameter to use 'temperature preset mode'.
* Factory default: 300°C for P1, 350°C for P2 and 400°C for P3

- Example**
- For setting the temperature according to the tip shape or application.
 - For the temperature setting by different operators.

One push of a button can quickly recall each setting.

A great change!

- Because 500°C is the maximum setting temperature, work which is assumed to suffer from insufficient thermal power can be done.

Thermal control function

- The temperature setting can be locked with the control card.
- An alarm can be set to inform that the preset lower limit has been reached.
- Easy temperature offset.

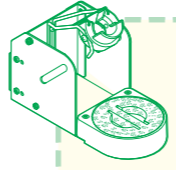

Auto sleep function

- Function to minimize oxidation of the tip and extend the service life of the tip

The auto sleep function activates for an arbitrarily-set time after the iron is inserted into the iron holder to decrease the tip temperature. (The auto sleep temperature setting range is 200°C to 300°C.) Setting the sleep temperature higher can reduce the time until start-up after releasing the sleep mode.

Auto power shut off function

- Energy-saving function

Auto power shut off activates 30 minutes after the iron is inserted into the iron holder and left unused.

Tip cleaner 599B included as a standard accessory

The tip cleaner with the water-free wire-type can be used instead of the cleaning sponge.

The auto power shut-off and auto sleep functions operate while linked to the iron holder.

* It is necessary to set up the connection before using the link function.

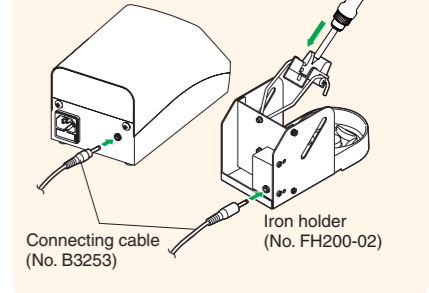

HAKKO FX-838 ESD SAFE SOLDERING STATION



Packing List

- ① HAKKO FX-838 soldering station..... 1
- ② HAKKO FX-8301 soldering iron..... 1
- ③ Control card..... 1
- ④ Power cord..... 1
- ⑤ Iron holder (With cleaning sponge and 599B)..... 1
- ⑥ Connecting cable..... 1
- ⑦ Heat resistant pad..... 1

* Tips are optional parts.

Optional Tips

Specifications

Model Name	HAKKO FX-838
Power Consumption	158W

Station

Output Voltage	27V
Temperature Range	200-500°C
Temperature Stability	±5°C
Dimensions	110(W) x 110(H) x 205(D)mm
Weight	3.2kg

HAKKO FX-8301 soldering iron

Power Consumption	150W
Tip to Ground Resistance	< 2Ω
Tip to Ground Potential	< 2mV
Heating Element	Ceramic heater
Length of Cord	1.2m
Length (w/o cord)	175mm with 2.4D tip
Weight (w/o cord)	31g with 2.4D tip

Replacement and Optional Parts

Part No.	Name/Description
FX8301-01	HAKKO FX-8301 27V/150W
B2388	Control card
FH200-01	HAKKO FH-200 /Cleaning wire type
FH200-02	HAKKO FH-200 /Cleaning sponge type
599B-02	HAKKO 599B tip cleaner
599-029	Cleaning wire
A1536	Cleaning sponge/green

Unit : mm

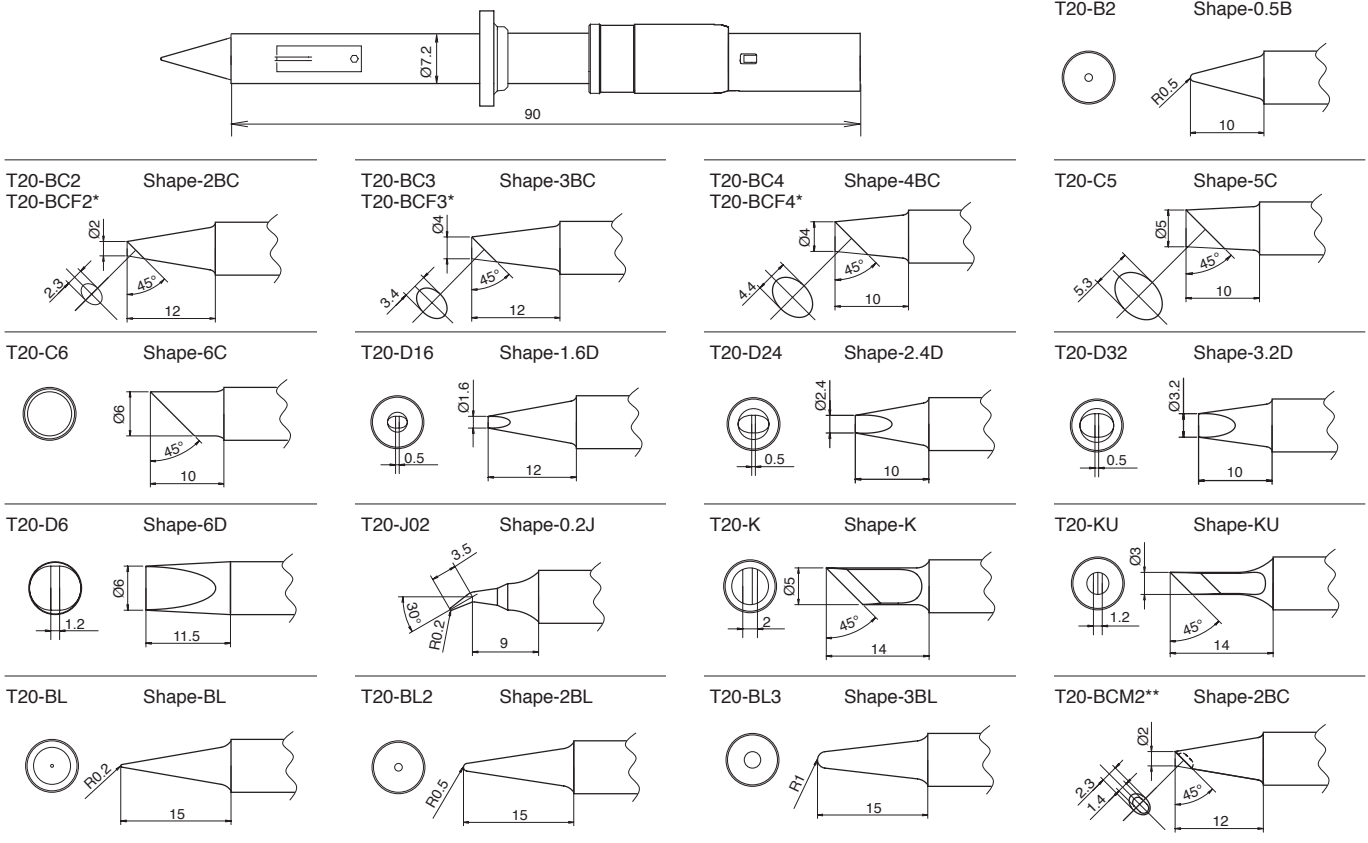

* These tips are tinned on the soldering surface only.

** The part numbers T20-BCM2 is not available for sale or use in the U.S.A.

HAKKO
HAKKO CORPORATION
OVERSEAS AFFILIATES

U.S.A.
AMERICAN HAKKO PRODUCTS, INC.
28920 N. AVE. WILLIAMS VALENCIA, CA 91355, U.S.A.
TEL: (661) 294-0090 FAX: (661) 294-0096
Toll Free (800)88-HAKKO
http://www.hakkousa.com

HEAD OFFICE
4-5, SHIOKUSA 2-CHOME, NANIWA-KU, OSAKA, 556-0024 JAPAN
TEL:+81-6-6561-3225 FAX:+81-6-6561-8466
http://www.hakko.com E-mail:sales@hakko.com

HONG KONG
HAKKO DEVELOPMENT CO., LTD.
ROOM 1504, EASTERN HARBOUR CENTRE,
28 HOI CHAK STREET, QUARRY BAY, HONG KONG.
TEL: 2811-5588 FAX: 2590-0217
http://www.hakko.com.hk
E-mail:info@hakko.com.hk

SINGAPORE
HAKKO PRODUCTS PTE., LTD.
1, GENTING LINK #02-04, PERFECT INDUSTRIAL
BUILDING, SINGAPORE 349518
TEL: 6748-2277 FAX: 6744-0033
http://www.hakko.com.sg
E-mail:sales@hakko.com.sg

CA00333BbBa002 2009.7

Please access to the following for the other Sales affiliates.
<http://www.hakko.com>

Specifications and design are subject to change without notice. Copyright Hakko Corporation. All right reserved.